

Spider  Farmer

USER MANUAL

SF-PlantStand

Everything Your Vegetables Need

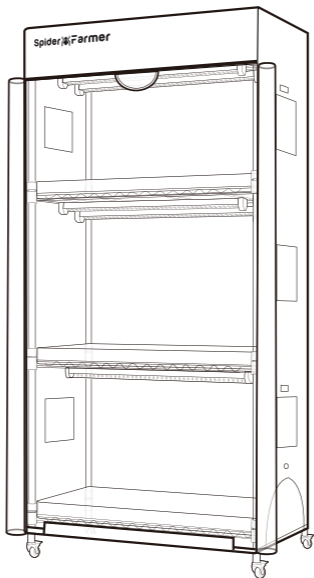

SF-PlantStand-01

SPECIFICATIONS

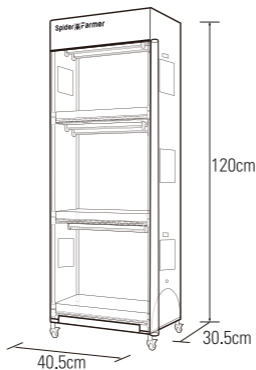

Model	SF-PlantStand60
Spectrum	Full Spectrum
Beam Angle	180±5Degrees
Input voltage range	85V to 265V AC
Frequency range	50Hz/60Hz
Input Power	9W(Single Bar)
Waterproof Level	IP65
Light Bar Quantity	6PCS
Single Bar size	30×3.5×3.2±0.2cm
Plant Stand Size	40X30X120cm
Tent Size	40.5*30.5*120cm
Tent Material	420D Oxford Cloth
Package Size	45*35*19.5cm
Gross Weight	8.7kg

SPECIFICATIONS

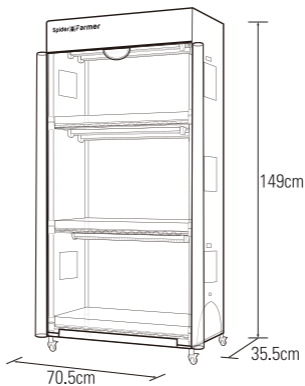





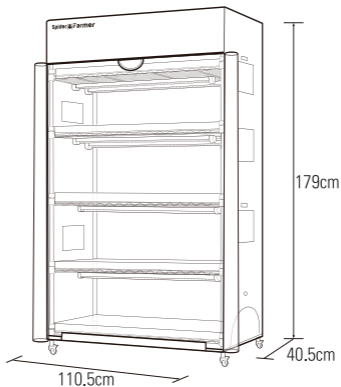





Model	SF-PlantStand110
Spectrum	Full Spectrum
Beam Angle	180±5Degrees
Input voltage range	85V to 265V AC
Frequency range	50Hz/60Hz
Input Power	18W(Single Bar)
Waterproof Level	IP65
Light Bar Quantity	6PCS
Single Bar size	60×3.5×3.2±0.2cm
Plant Stand Size	70X35X150cm
Tent Size	70.5*35.5*149cm
Tent Material	420D Oxford Cloth
Package Size	74.5*39*21cm
Gross Weight	12.8kg

SPECIFICATIONS



Model	SF-PlantStand230
Spectrum	Full Spectrum
Beam Angle	180±5Degrees
Input voltage range	85V to 265V AC
Frequency range	50Hz/60Hz
Input Power	22W(Single Bar)
Waterproof Level	IP65
Light Bar Quantity	10PCS
Single Bar size	90×3.5×3.2±0.2cm
Plant Stand Size	110X40X180cm
Tent Size	110.5*40.5*179cm
Tent Material	420D Oxford Cloth
Package Size	114*44.5*27cm
Gross Weight	25.2kg

PRODUCT LIST

	Model (SF-)	PlantStand60	PlantStand110	PlantStand230
	Light Bar	6	6	10
	150cm Power Cable	1	1	1
	35cm Connecting Cable	3	3	5
	60cm Connecting Cable	2	2	4
	Plastic Tie	16	16	24
	Metal Clip	12	12	20
	Waterproof Cap	1	1	1
	Wire Mesh	4	4	6
	Bottom pole with feet	4(40cm)	4(60cm)	4(89cm)
	Middle pole connecting pole	4(40cm)	4(30cm)	/
	Top pole with top end	4(40cm)	4(60cm)	4(89cm)
	Plastic Clip	36	36	54
	Caster with Lock	4	4	4
	Waterproof Mat	3	3	5
	Semi-Transparent Tent	1	1	1

ASSEMBLY INSTRUCTIONS

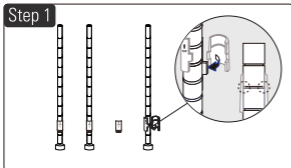

Take out the four bottom pole with feet. Secure the plastic clips at the same height on each pole. It will utter a sound while installing well the clip. (Set the height according to your needs, making sure the "TOP" side of the clip faces up.)

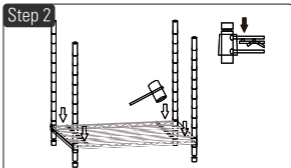

Slide the wire mesh onto the four poles, stand it up, and gently tap the connections to secure them.

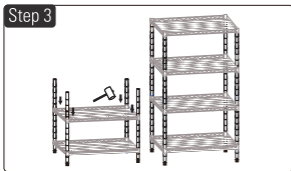

Use the four middle poles to spiral tighten clockwise with the bottom poles. Repeat the previous steps to install the second and subsequent layers.

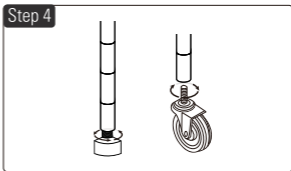

Lay the shelf down, unscrew the feet, and replace them with casters if needed.

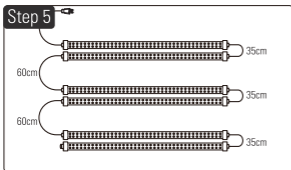

Connect the lights as shown, ensuring the correct positioning of the 35 cm and 60 cm connection cables. Install the waterproof cap on the last light bar.

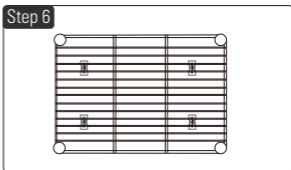

Thread plastic ties through the metal clips and secure the clips to the wire mesh.

ASSEMBLY INSTRUCTIONS

Step 7



Snap the light bars into the metal clips. Repeat this step to install the remaining light bars.

Step 8

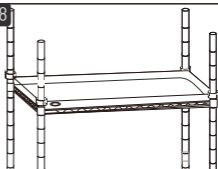

Place the waterproof mat on the wire mesh, ensuring the drainage holes face outward. Secure the four corners with ties.

Step 9



Slide the tent cover over the top, secure it inside with ties, and zip it up. Use the Velcro to seal the openings. Done!

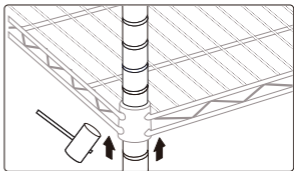

Disassembly Method: Gently tap upward on the four corners of the sleeve to remove the wire mesh panel.

Notes

1. This product is for indoor use only and has a waterproof rating of IP65.
2. Before using the product, please check that the lights are not damaged from transportation. If you find any damage, contact us immediately.
3. Install the product on a flat surface without any vibration, shaking, or fire hazards.
4. As a semiconductor product, the lights are sensitive to temperature. To extend their lifespan, keep them away from heat sources, ensure proper ventilation, and maintain a temperature between 0°C and 25°C.

YOUR RELIABLE INDOOR GROW PARTNER

Our Social Media



Contact:

Email: support@spider-farmer.com

info@spider-farmer.com